

**INSULATED GATE BIPOLAR TRANSISTOR
WITH ULTRAFAST SOFT RECOVERY DIODE**

Fast CoPack IGBT

Features

- Switching-loss rating includes all "tail" losses
- HEXFRED™ soft ultrafast diodes
- Optimized for medium operating frequency (1 to 10kHz) See Fig. 1 for Current vs. Frequency curve

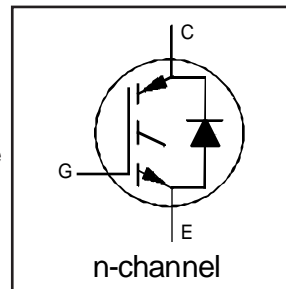

$V_{CES} = 600V$

$V_{CE(sat)} \leq 2.1V$

@ $V_{GE} = 15V, I_C = 17A$

Description

Co-packaged IGBTs are a natural extension of International Rectifier's well known IGBT line. They provide the convenience of an IGBT and an ultrafast recovery diode in one package, resulting in substantial benefits to a host of high-voltage, high-current, motor control, UPS and power supply applications.

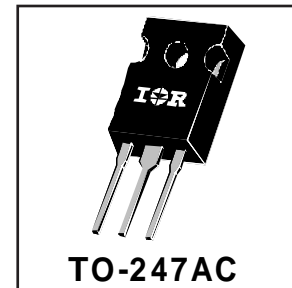

Absolute Maximum Ratings

	Parameter	Max.	Units
V_{CES}	Collector-to-Emitter Voltage	600	V
$I_C @ T_C = 25^\circ C$	Continuous Collector Current	31	A
$I_C @ T_C = 100^\circ C$	Continuous Collector Current	17	
I_{CM}	Pulsed Collector Current ①	120	
I_{LM}	Clamped Inductive Load Current ②	120	
$I_F @ T_C = 100^\circ C$	Diode Continuous Forward Current	12	
I_{FM}	Diode Maximum Forward Current	120	
V_{GE}	Gate-to-Emitter Voltage	± 20	V
$P_D @ T_C = 25^\circ C$	Maximum Power Dissipation	100	W
$P_D @ T_C = 100^\circ C$	Maximum Power Dissipation	42	
T_J	Operating Junction and Storage Temperature Range	-55 to +150	°C
T_{STG}			
	Mounting Torque, 6-32 or M3 Screw.	10 lbf•in (1.1 N•m)	

Thermal Resistance

	Parameter	Min.	Typ.	Max.	Units
$R_{\theta JC}$	Junction-to-Case - IGBT	-----	-----	1.2	°C/W
$R_{\theta JC}$	Junction-to-Case - Diode	-----	-----	2.5	
$R_{\theta CS}$	Case-to-Sink, flat, greased surface	-----	0.24	-----	
$R_{\theta JA}$	Junction-to-Ambient, typical socket mount	-----	-----	40	
Wt	Weight	-----	6 (0.21)	-----	g (oz)

IRGPC30FD2



Electrical Characteristics @ T_J = 25°C (unless otherwise specified)

	Parameter	Min.	Typ.	Max.	Units	Conditions
V _{(BR)CES}	Collector-to-Emitter Breakdown Voltage ^③	600	----	----	V	V _{GE} = 0V, I _C = 250μA
ΔV _{(BR)CES} /ΔT _J	Temperature Coeff. of Breakdown Voltage	----	0.69	----	V/°C	V _{GE} = 0V, I _C = 1.0mA
V _{CE(on)}	Collector-to-Emitter Saturation Voltage	----	1.8	2.1	V	I _C = 17A, V _{GE} = 15V
		----	2.4	----		I _C = 31A, V _{GE} = 15V
		----	2.2	----		I _C = 17A, T _J = 150°C
V _{GE(th)}	Gate Threshold Voltage	3.0	----	5.5		V _{CE} = V _{GE} , I _C = 250μA
ΔV _{GE(th)} /ΔT _J	Temperature Coeff. of Threshold Voltage	----	-11	----	mV/°C	V _{CE} = V _{GE} , I _C = 250μA
g _{fe}	Forward Transconductance ^④	6.1	10	----	S	V _{CE} = 100V, I _C = 17A
I _{CES}	Zero Gate Voltage Collector Current	----	----	250	μA	V _{GE} = 0V, V _{CE} = 600V
		----	----	2500		V _{GE} = 0V, V _{CE} = 600V, T _J = 150°C
V _{FM}	Diode Forward Voltage Drop	----	1.4	1.7	V	I _C = 12A, V _{GE} = 15V
		----	1.3	1.6		I _C = 12A, T _J = 150°C
I _{GES}	Gate-to-Emitter Leakage Current	----	----	±100	nA	V _{GE} = ±20V

Switching Characteristics @ T_J = 25°C (unless otherwise specified)

	Parameter	Min.	Typ.	Max.	Units	Conditions
Q _g	Total Gate Charge (turn-on)	----	27	30	nC	I _C = 17A
Q _{ge}	Gate - Emitter Charge (turn-on)	----	4.1	5.9		V _{CC} = 400V
Q _{gc}	Gate - Collector Charge (turn-on)	----	12	15		See Fig. 8
t _{d(on)}	Turn-On Delay Time	----	72	----	ns	T _J = 25°C
t _r	Rise Time	----	75	----		I _C = 17A, V _{CC} = 480V
t _{d(off)}	Turn-Off Delay Time	----	300	450		V _{GE} = 15V, R _G = 23Ω
t _f	Fall Time	----	220	350	mJ	Energy losses include "tail" and diode reverse recovery.
E _{on}	Turn-On Switching Loss	----	0.9	----		See Fig. 9, 10, 11, 18
E _{off}	Turn-Off Switching Loss	----	2.1	----		
E _{ts}	Total Switching Loss	----	3.0	4.6		
t _{d(on)}	Turn-On Delay Time	----	70	----	ns	T _J = 150°C, See Fig. 9, 10, 11, 18
t _r	Rise Time	----	75	----		I _C = 17A, V _{CC} = 480V
t _{d(off)}	Turn-Off Delay Time	----	420	----		V _{GE} = 15V, R _G = 23Ω
t _f	Fall Time	----	480	----	mJ	Energy losses include "tail" and diode reverse recovery.
E _{ts}	Total Switching Loss	----	4.7	----		
L _E	Internal Emitter Inductance	----	13	----		nH
C _{ies}	Input Capacitance	----	670	----	pF	V _{GE} = 0V
C _{oes}	Output Capacitance	----	100	----		V _{CC} = 30V
C _{res}	Reverse Transfer Capacitance	----	10	----		f = 1.0MHz
t _{rr}	Diode Reverse Recovery Time	----	42	60	ns	T _J = 25°C See Fig. 14
		----	80	120		T _J = 125°C
I _{rr}	Diode Peak Reverse Recovery Current	----	3.5	6.0	A	T _J = 25°C See Fig. 15
		----	5.6	10		T _J = 125°C
Q _{rr}	Diode Reverse Recovery Charge	----	80	180	nC	T _J = 25°C See Fig. 16
		----	220	600		T _J = 125°C
μs	d _(rec) /dt Diode Peak Rate of Fall of Recovery	----	----	----	----	180
		A/μs	T _J = 25°C See Fig. 17	----		During t _b

Notes:

- ① Repetitive rating; V_{GE}=20V, pulse width limited by max. junction temperature. (See fig. 20)
- ② V_{CC}=80%(V_{CES}), V_{GE}=20V, L=10μH, R_G = 23Ω, (See fig. 19)
- ③ Pulse width ≤ 80μs; duty factor ≤ 0.1%.
- ④ Pulse width 5.0μs, single shot.

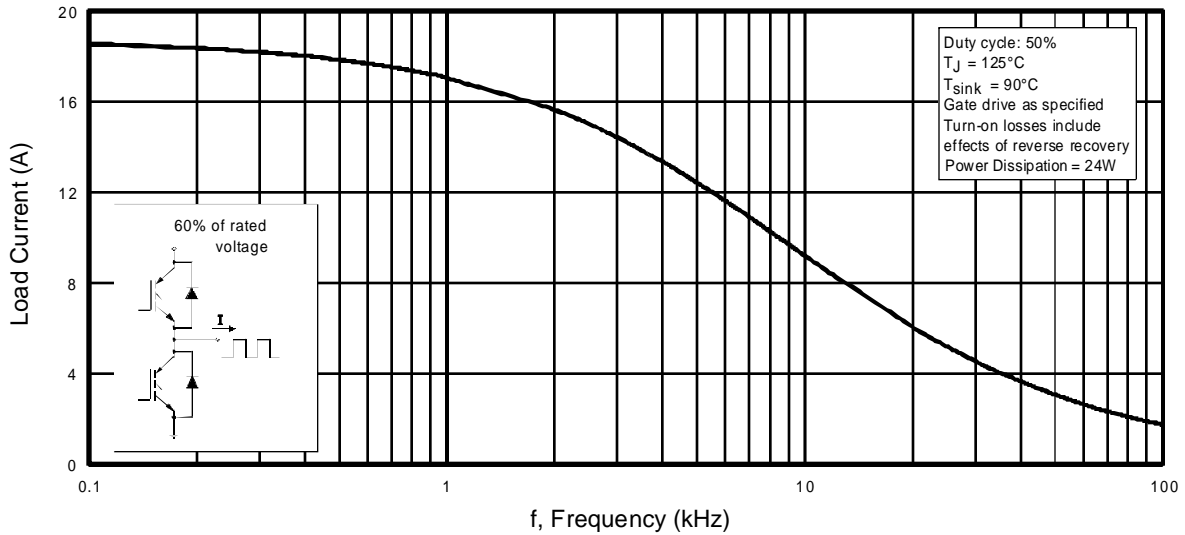

Fig. 1 - Typical Load Current vs. Frequency
(Load Current = I_{RMS} of fundamental)

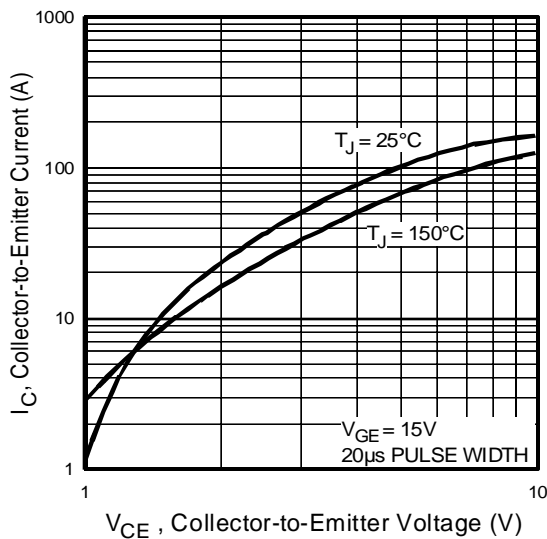

Fig. 2 - Typical Output Characteristics

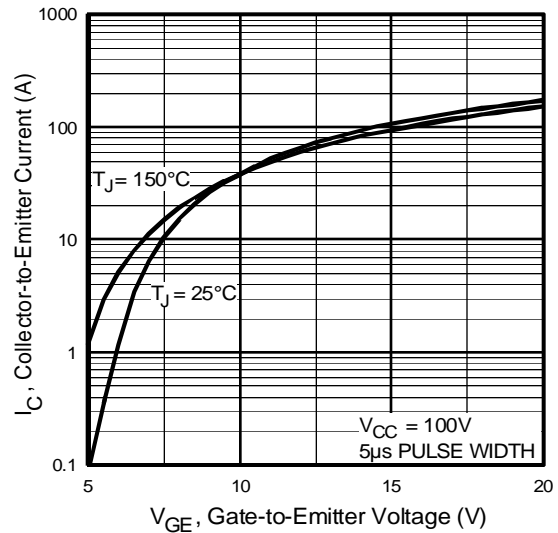

Fig. 3 - Typical Transfer Characteristics

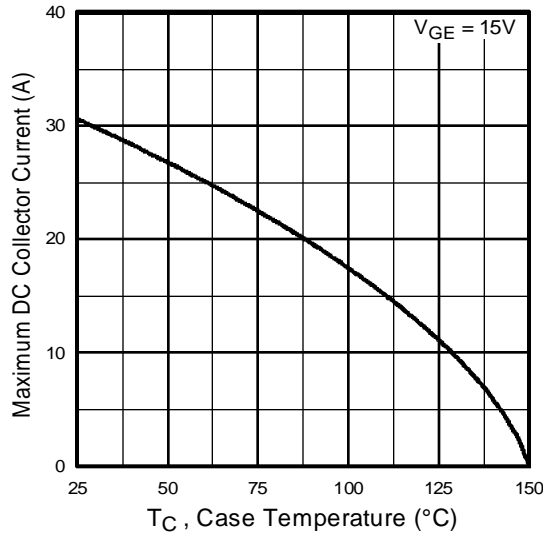

Fig. 4 - Maximum Collector Current vs. Case Temperature

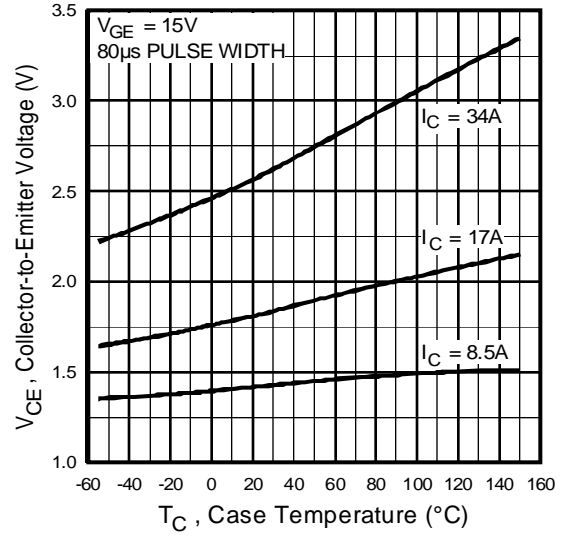

Fig. 5 - Collector-to-Emitter Voltage vs. Case Temperature

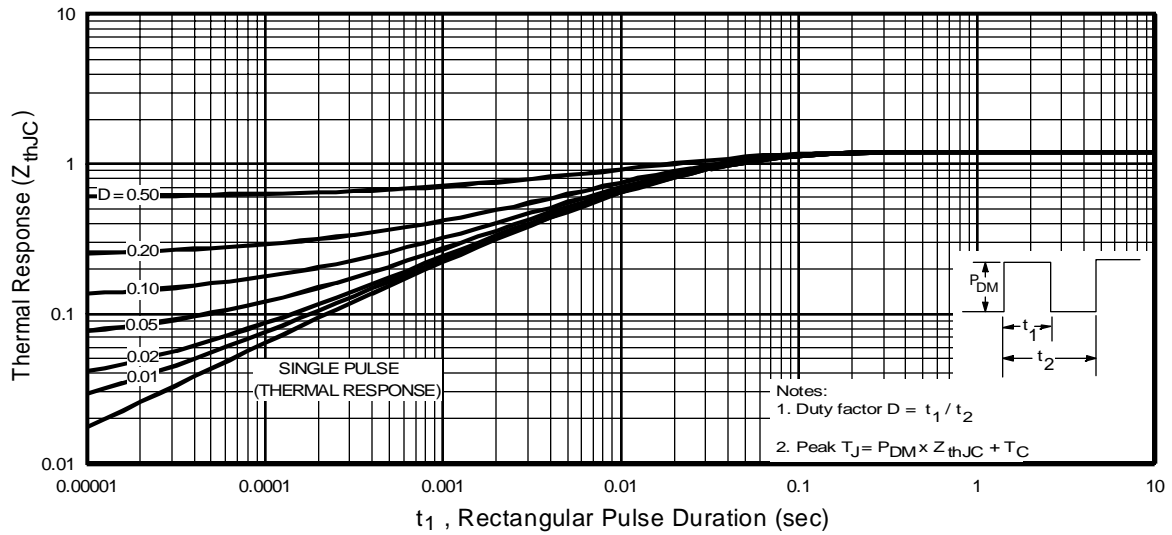

Fig. 6 - Maximum IGBT Effective Transient Thermal Impedance, Junction-to-Case

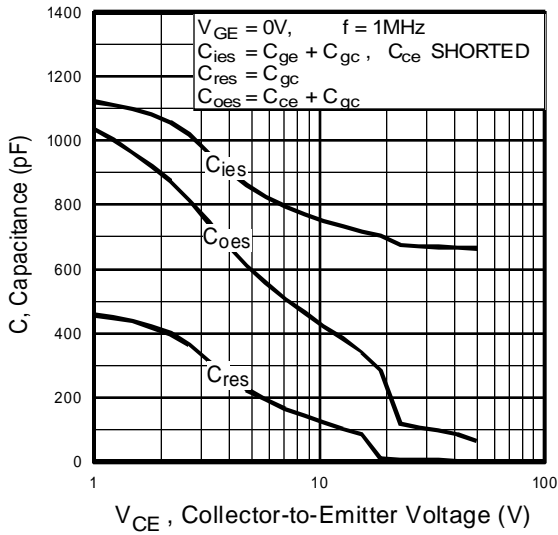

Fig. 7 - Typical Capacitance vs. Collector-to-Emitter Voltage

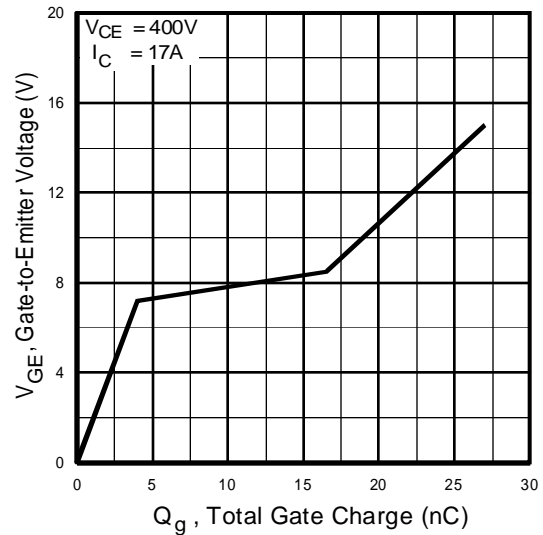

Fig. 8 - Typical Gate Charge vs. Gate-to-Emitter Voltage

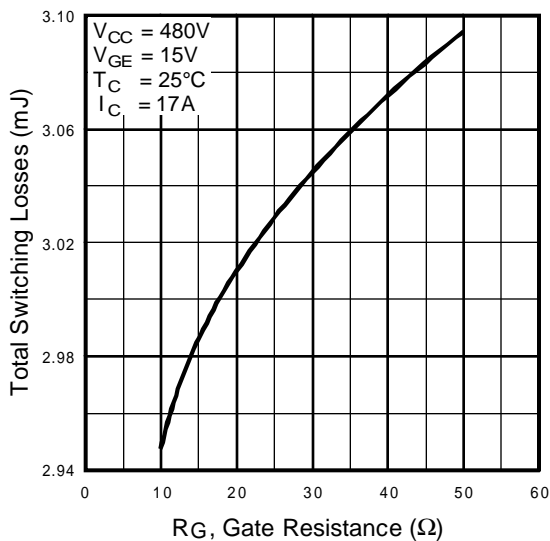

Fig. 9 - Typical Switching Losses vs. Gate Resistance

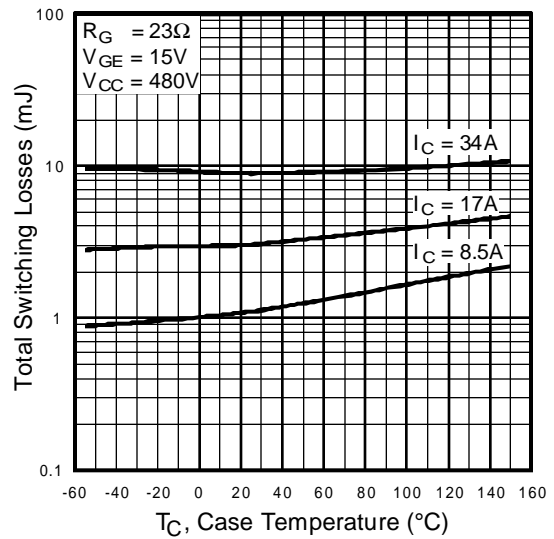

Fig. 10 - Typical Switching Losses vs. Case Temperature

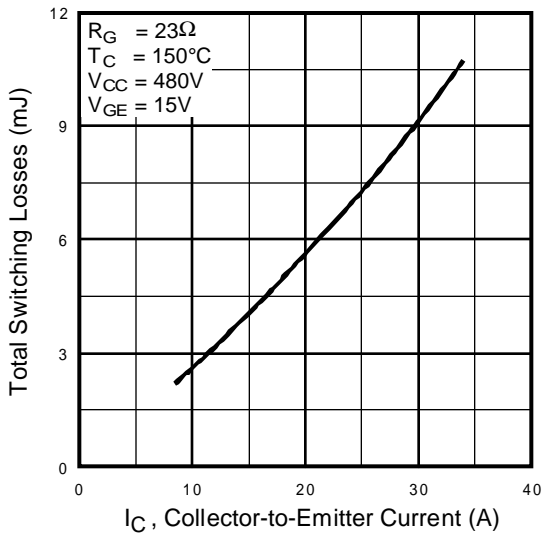

Fig. 11 - Typical Switching Losses vs. Collector-to-Emitter Current

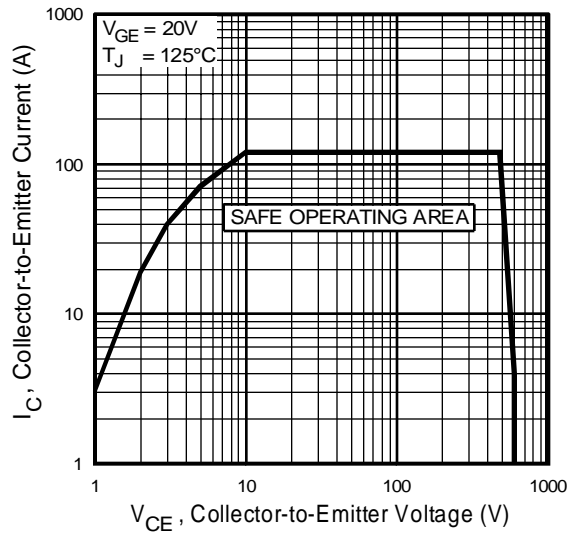

Fig. 12 - Turn-Off SOA

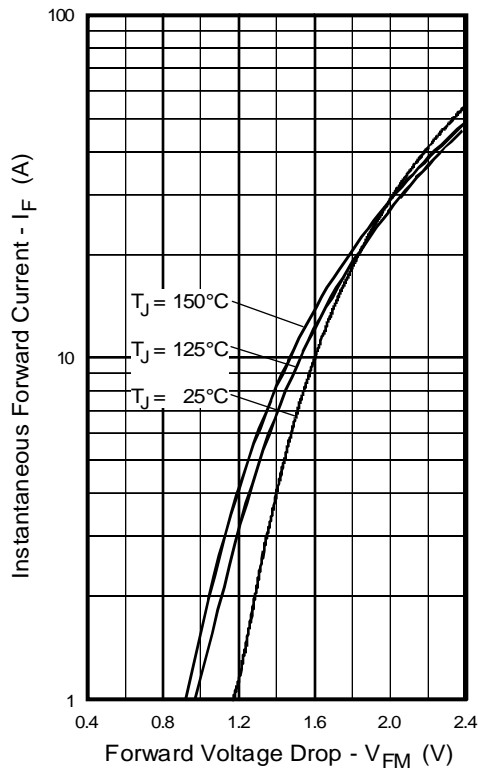

Fig. 13 - Maximum Forward Voltage Drop vs. Instantaneous Forward Current

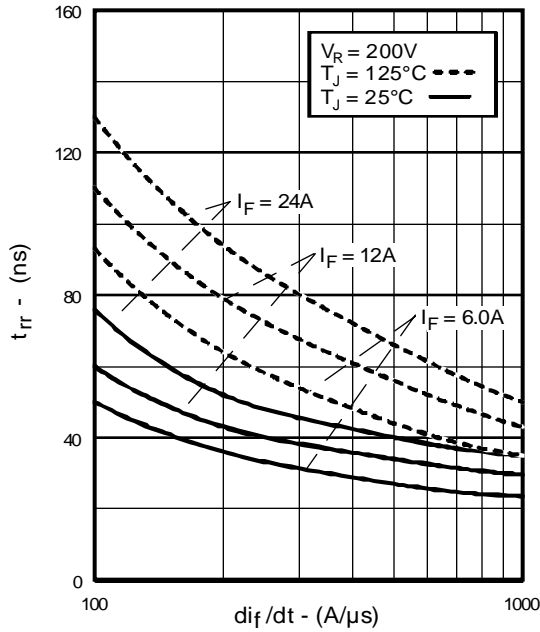

Fig. 14 - Typical Reverse Recovery vs. di_f/dt

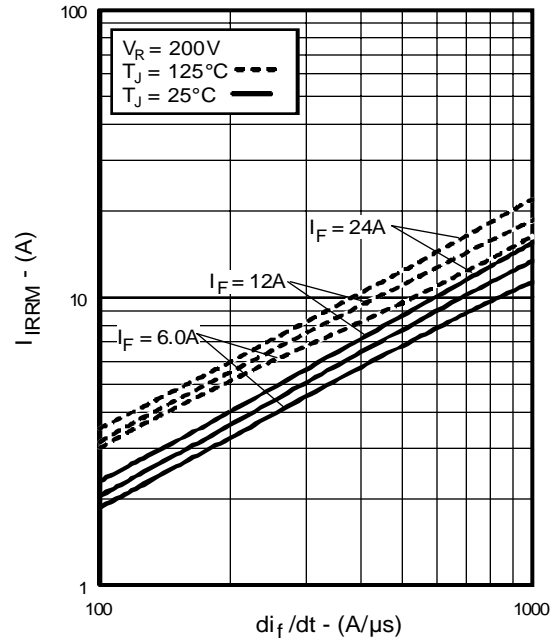

Fig. 15 - Typical Recovery Current vs. di_f/dt

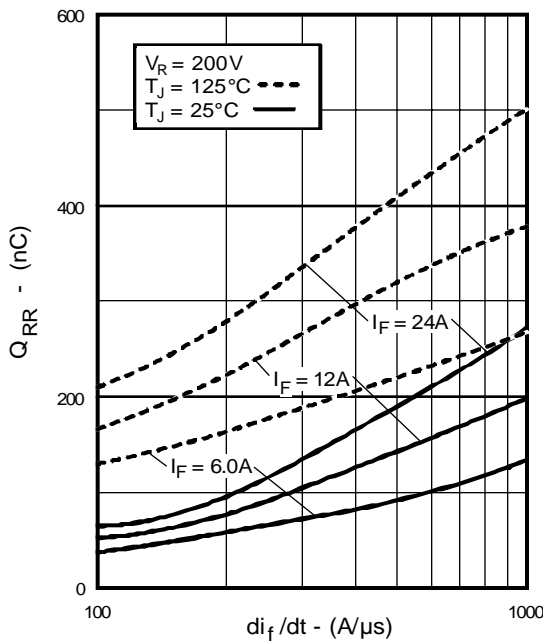

Fig. 16 - Typical Stored Charge vs. di_f/dt

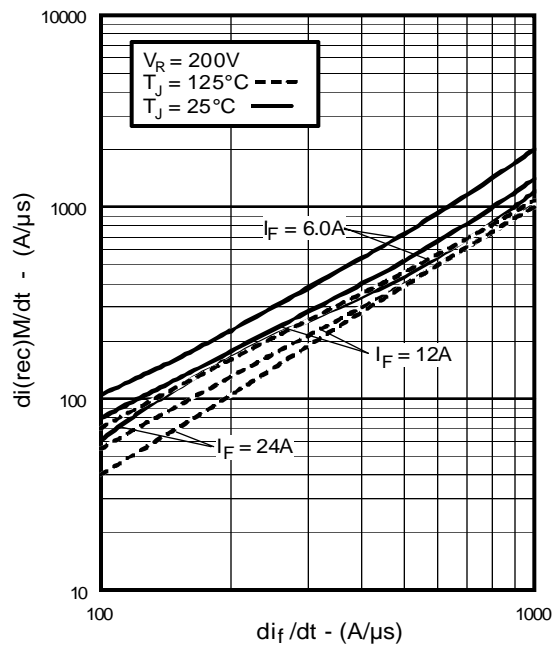

Fig. 17 - Typical $di_{(rec)M}/dt$ vs. di_f/dt

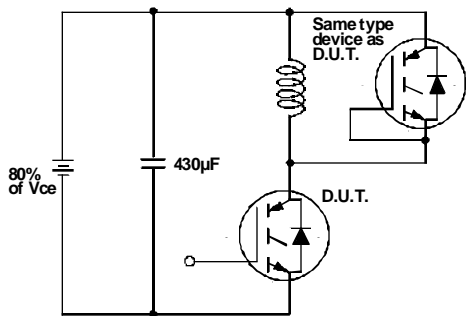

Fig. 18a - Test Circuit for Measurement of I_{LM} , E_{on} , $E_{off}(\text{diode})$, t_{rr} , Q_{rr} , I_{rr} , $t_{d(on)}$, t_r , $t_{d(off)}$, t_f

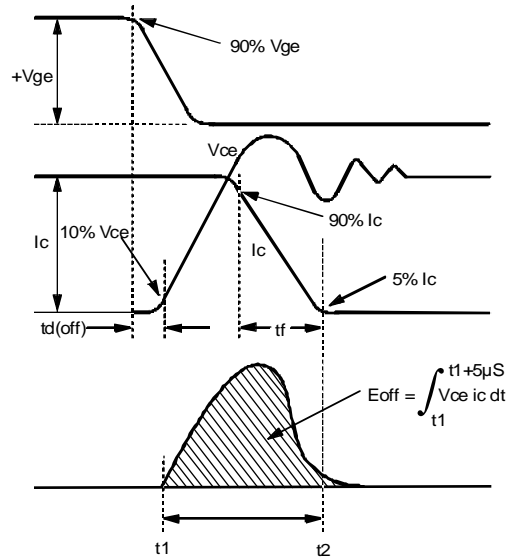

Fig. 18b - Test Waveforms for Circuit of Fig. 18a, Defining E_{off} , $t_{d(off)}$, t_f

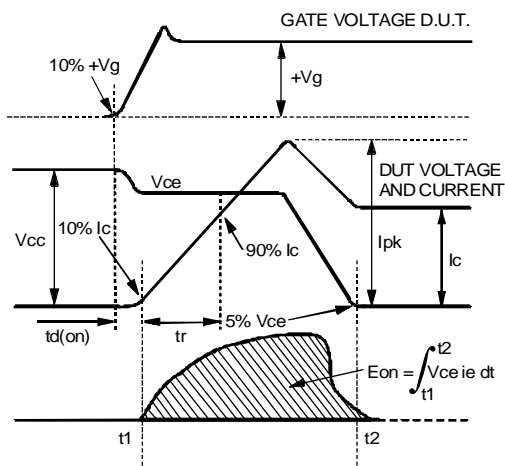

Fig. 18c - Test Waveforms for Circuit of Fig. 18a, Defining E_{on} , $t_{d(on)}$, t_r

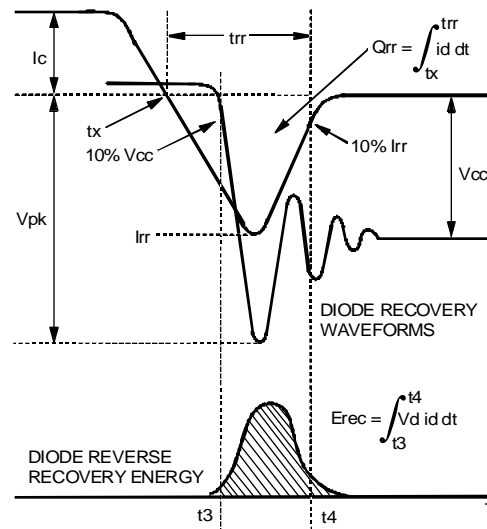

Fig. 18d - Test Waveforms for Circuit of Fig. 18a, Defining E_{rec} , t_{rr} , Q_{rr} , I_{rr}



IRGPC30FD2

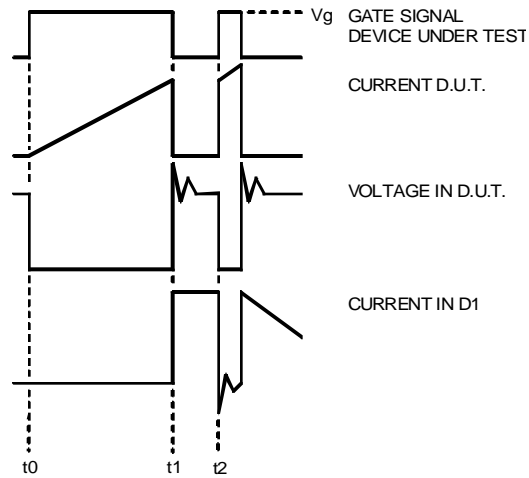

Fig. 18e - Macro Waveforms for Test Circuit of Fig. 18a

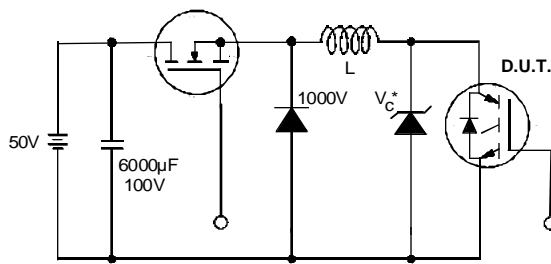

Fig. 19 - Clamped Inductive Load Test Circuit

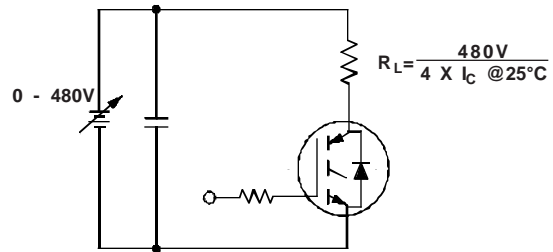
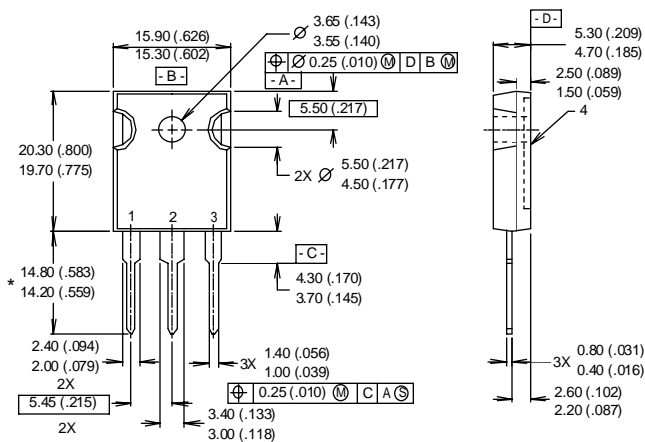

Fig. 20 - Pulsed Collector Current Test Circuit



- NOTES:
- 1 DIMENSIONS & TOLERANCING PER ANSI Y14.5M, 1982.
 - 2 CONTROLLING DIMENSION: INCH.
 - 3 DIMENSIONS ARE SHOWN MILLIMETERS (INCHES).
 - 4 CONFORMS TO JEDEC OUTLINE TO-247AC.

- LEAD ASSIGNMENTS
- 1 - GATE
 - 2 - COLLECTOR
 - 3 - EMITTER
 - 4 - COLLECTOR

* LONGER LEADED (20mm) VERSION AVAILABLE (TO-247AD) TO ORDER ADD "E" SUFFIX TO PART NUMBER

CONFORMS TO JEDEC OUTLINE TO-247AC (TO-3P)
Dimensions in Millimeters and (Inches)